



PUHY-RP600YSJM-B

Replace Multi Y Series 24hp Outdoor Unit

R410A Heat Pump

The latest VRF Replace Multi from Mitsubishi Electric is specifically designed for the maturing refurbishment sector, enabling the reuse of existing R22/R407c pipework, whilst also allowing the upgrade to some of the most efficient systems available in the market.

- **Tried and tested technology that's been employed for over 5 years**
- **Efficient use of existing resources - refrigerant piping, control and power wiring and less waste materials**
- **Reduced installation time with minimised disruption**
- **Ability to replace many non Mitsubishi Electric systems**



Pictures not to scale



Product Details

PUHY-RP600YSJM-B	
Capacity (kW):	
Heating (Nominal)	76.5
Cooling (Nominal)	69.0
Heating (UK)	73.4
Cooling (UK)	63.5
Power Input (kW) Heating (Nominal)	19.22
Power Input (kW) Cooling (Nominal)	18.59
Power Input (kW) Heating (UK)	24.6
Power Input (kW) Cooling (UK)	13.01
Max No. of Connectable Indoor Units	32
Airflow(m ³ /min)	185 /185
Noise (dBA)	62
Width - mm	920 + 920
Depth - mm	760
Height - mm	1710
Weight - kg	255 + 255
Electrical Supply	380-415v, 50Hz
Phase	3
Mains Cable No. Cores	4 + earth
Starting Current (A)	8
Running Current (A) - Heating	31.1
Running Current (A) - Cooling	30.8

Piping Restrictions

Total Piping Length (m)	250
Furthest Piping Length (m)	120
Furthest Piping Length after 1st Branch (m)	40
Between Indoor and Outdoor Units - Height (m)	50
Between Indoor and Indoor Units - Height (m)	15

Dimensions

PUHY-RP600YSJM-B

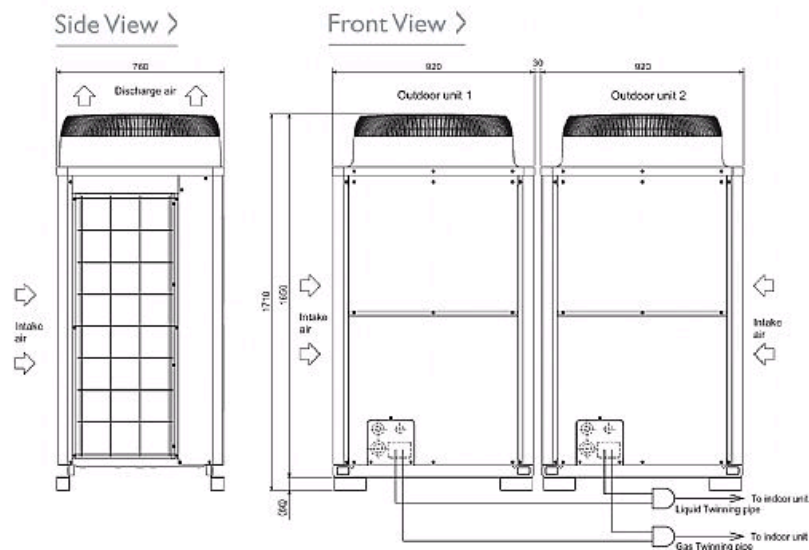

Telephone: 01707 282880

Email: air.conditioning@meuk.mee.com Website: <http://www.mitsubishielectric.co.uk/aircon>

Mitsubishi Electric reserves the right to make any variation in technical specification to the equipment described, or to withdraw or replace products without prior notification or public announcement.

Tel:
Fax:

